

PK 7.001 SLD 1
PK 7.001 SLD 3
PK 7.501 SLD 5



HIGHER PAYLOAD DUE TO INTELLIGENT LIGHTWEIGHT DESIGN



PK 7.001 SLD 1 (NON-CE)

STD

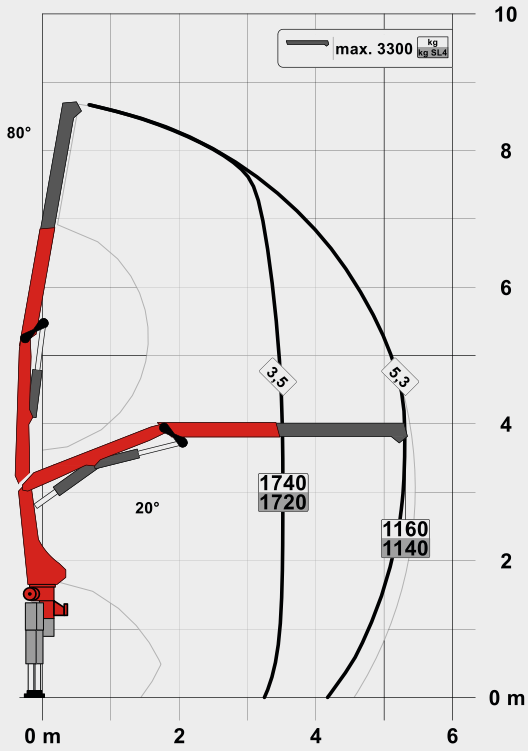

A

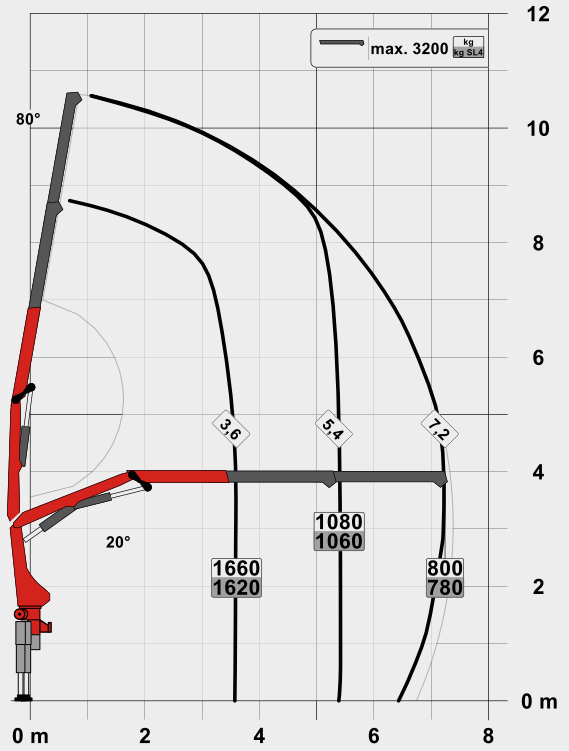

C

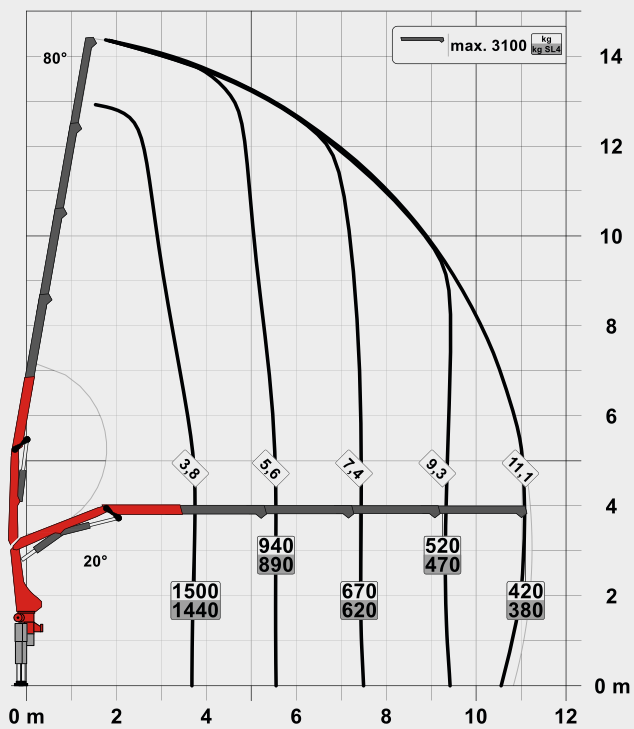

PERFECT DIMENSIONS

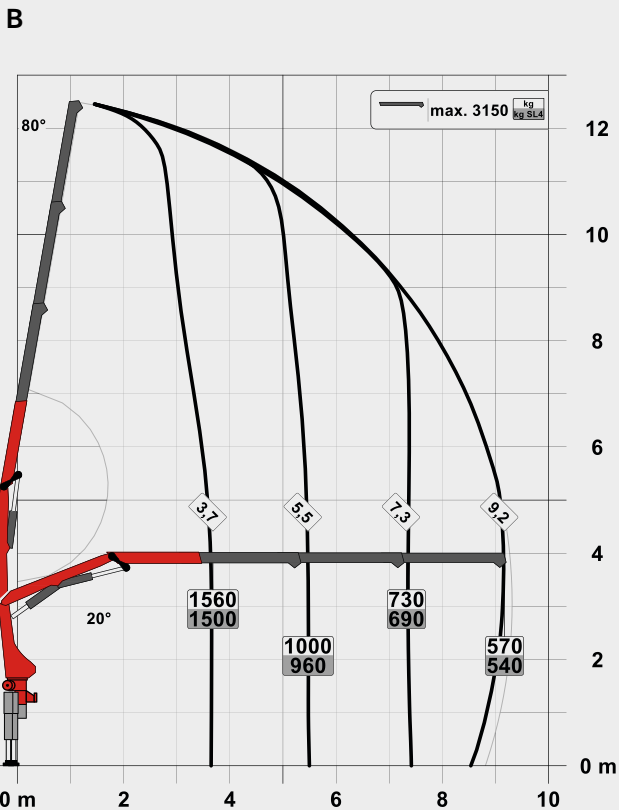

SLD 1 (NON-CE)

- Single Link
- Optional:
 - Overload protection OSK
 - Radio remote control
- NON-CE model

TECHNICAL SPECIFICATIONS

Classification	EN 13001 HC1 HD4/S2	
Max. lifting moment	6.2 mt/60.4 kNm	44530 ft.lb
Max. lifting capacity	3300 kg/32.4 kN	7300 lb
Max. hydraulic outreach	11.2 m	36' 9"
Max. manual outreach	12.9 m	41' 12"
Slewing angle	400°	
Slewing torque	0.8 mt/7.8 kNm	5750 ft.lb
Stabiliser spread (std./max.)	3.0 m/ 5.0 m	9' 10"/ 16' 3"
Fitting space required (std.)	0.66 m	2' 2"
Width folded	2.2 m / 7' 3"	
Max. operating pressure	330 bar	4785 psi
Recommended pump capacity	from 20 l/min	5.3 US gpm
	to 30 l/min	7.9 US gpm
Dead weight (std.)	750 kg	1650 lb

PK 7.001 SLD 3

STD

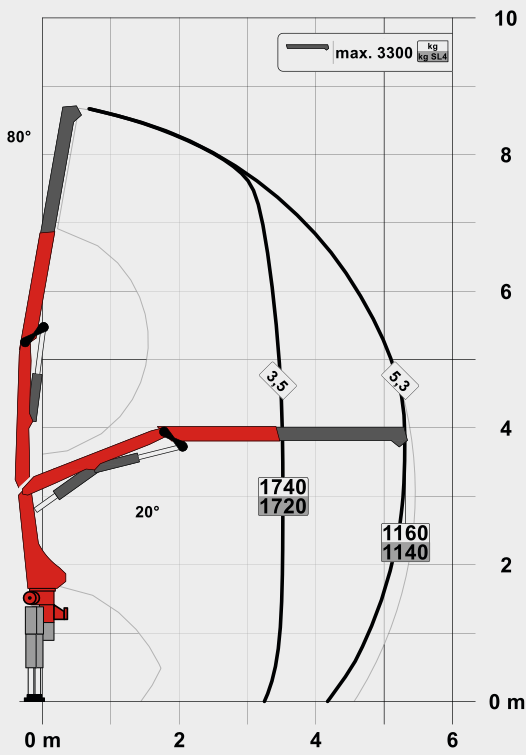

A

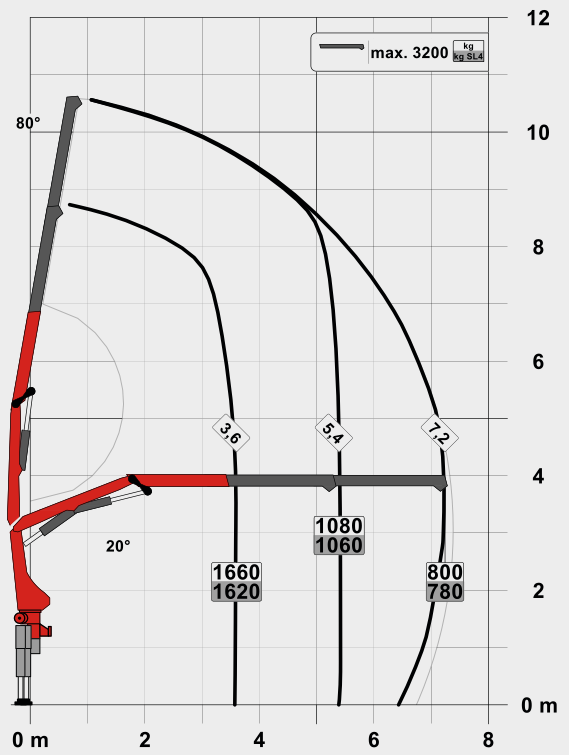

C

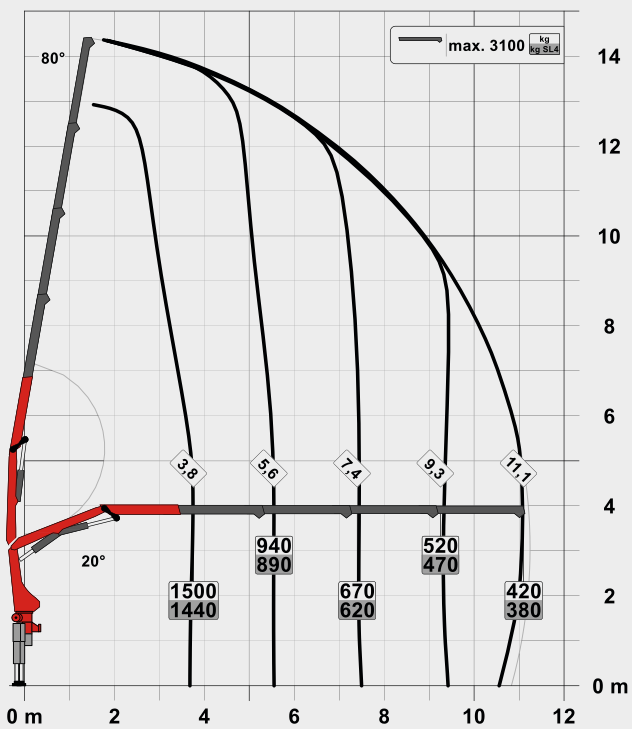

PERFECT DIMENSIONS

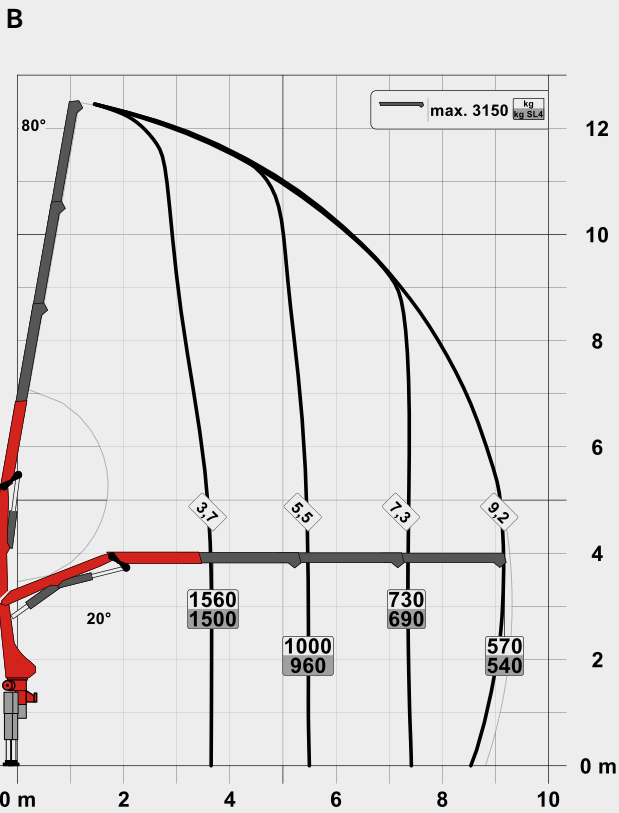

SLD 3

- Single Link
- Paltronic overload protection
- Optional:
 - Stability monitoring system ISC-S (standard for CE), HPSC-L, HPSC-E
 - Radio remote control
- NON-CE and CE model

TECHNICAL SPECIFICATIONS

Classification	EN 13001 HC1 HD4/S2	
Max. lifting moment	6.2 mt/60.4 kNm	44530 ft.lb
Max. lifting capacity	3300 kg/32.4 kN	7300 lb
Max. hydraulic outreach	11.2 m	36' 9"
Max. manual outreach	12.9 m	41' 12"
Slewing angle	400°	
Slewing torque	0.8 mt/7.8 kNm	5750 ft.lb
Stabiliser spread (std./max.)	3.0 m/ 5.0 m	9' 10"/ 16' 3"
Fitting space required (std.)	0.66 m	2' 2"
Width folded	2.2 m	7' 3"
Max. operating pressure	330 bar	4785 psi
Recommended pump capacity	from 20 l/min	5.3 US gpm
	to 30 l/min	7.9 US gpm
Dead weight (std.)	750 kg	1650 lb

PK 7.501 SLD 5

STD

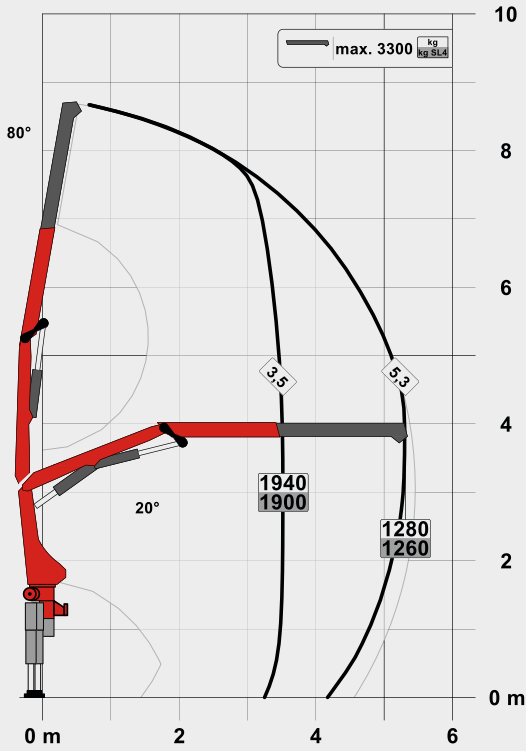

A

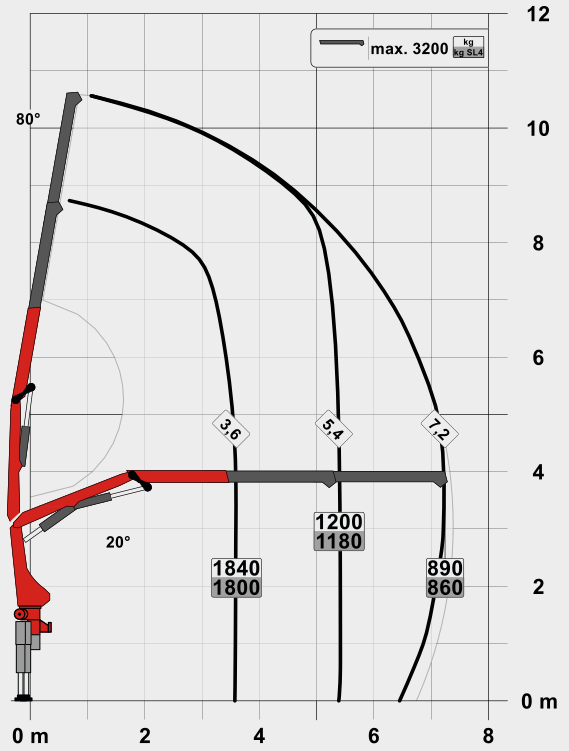

C

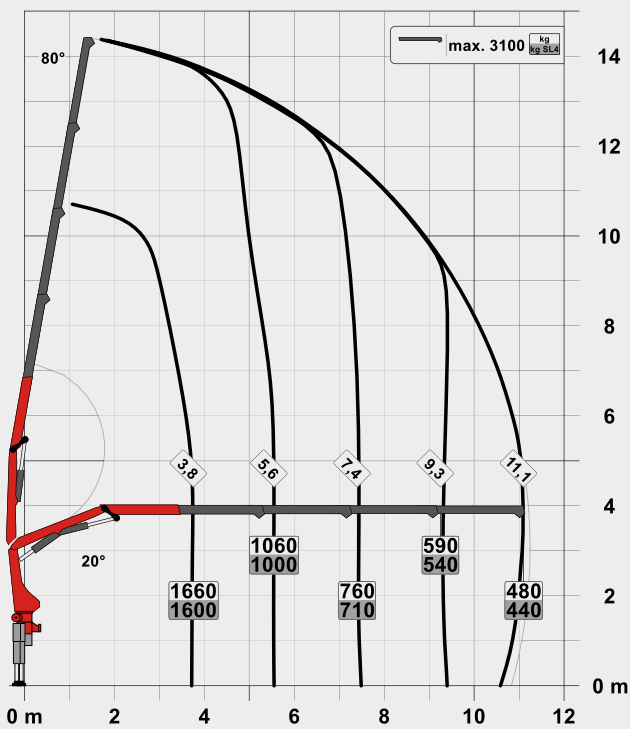

PERFECT DIMENSIONS

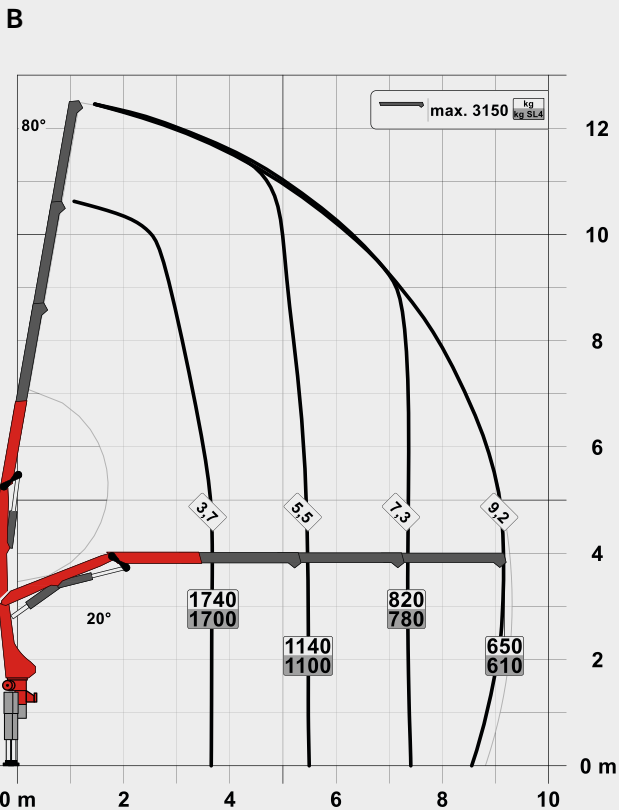

SLD 5

- Single Link
- Paltronic overload protection
- E-HPLS
- Load Sensing valve
- Radio remote control with LED display
- Optional:
 - Stability monitoring system ISC-S (standard for CE), HPSC-L, HPSC-E
- NON-CE and CE model

TECHNICAL SPECIFICATIONS

Classification	EN 13001 HC1 HD4/S2	
Max. lifting moment	6.8 mt/66.9 kNm	49340 ft.lb
Max. lifting capacity	3300 kg/32.4 kN	7300 lb
Max. hydraulic outreach	11.2 m	36' 9"
Max. manual outreach	12.9 m	41' 12"
Slewing angle	400°	
Slewing torque	0.8 mt/7.8 kNm	5750 ft.lb
Stabiliser spread (std./max.)	3.0 m/ 5.0 m	9' 10"/ 16' 3"
Fitting space required (std.)	0.66 m	2' 2"
Width folded	2.2 m	7' 3"
Max. operating pressure	360 bar	5220 psi
Recommended pump capacity	from 30 l/min	7.9 US gpm
	to 40 l/min	10.6 US gpm
Dead weight (std.)	780 kg	1720 lb

DIMENSIONS

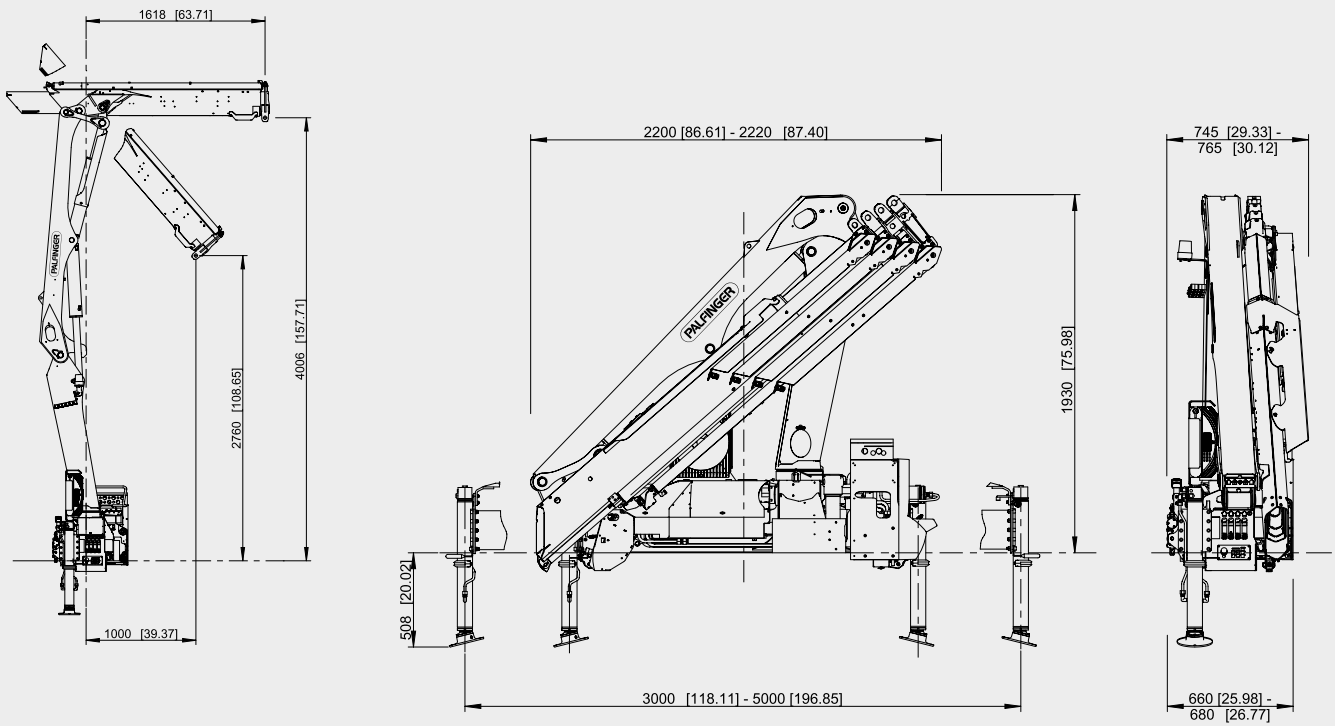

Cranes shown in the leaflet are partially optional equipped and do not always correspond to the standard version. Country-specific regulations must be observed. Dimensions may vary. Subject to technical changes, errors and translation mistakes.